

# A25X

## SEMICONDUCTOR PROTECTION FUSES



A25X Amp-trap® Form 101 Semiconductor Protection fuses were designed for heavy duty rectifiers such as those used in the electro-chemical industry. Originally designed for diode protection, A25X fuses have been particularly reliable in heavy duty applications of many types.

Note: Recommended as replacement fuses only

### Features/Benefits

- **Low I<sup>2</sup>t** minimizes damage to protected component on short circuit
- **Controlled arc voltage** reduces stress to circuit components during fuse clearing
- **Choice of mounting types** helps in equipment design

### Ratings

- **AC:** 10-30A  
300VAC, 50kA I.R.
- 35-60A  
250 VAC, 100kA I.R.
- 70-800A  
250VAC, 10,600 A I.R.
- 1000-4500A  
250VAC

### Approvals

- UL Recognized Component
- AC: UL Guide No. JFHR2 (10-250A)

### HIGHLIGHTS:

- Fast Acting
- Current Limiting
- Low I<sup>2</sup>t
- Indicator Options Available

### APPLICATIONS:

- Protection of 250 volt heavy duty rectifiers and similar heavy power supplies



### Single Pole Fuse Blocks for A25X Fuses

FUSE AMPERE RATING	FUSE BLOCK CATALOG NUMBER
1-30	20306
31-60	P243G
61-100	P243
101-200	P243
201-400	P243G
401-700	P243G



### Catalog Numbering System

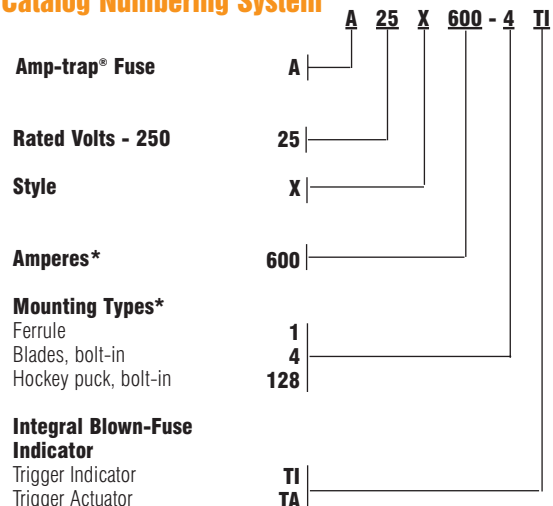

\* For ampere ratings and types not listed, consult the factory.

# A25X

## SEMICONDUCTOR PROTECTION FUSES

### Standard Fuse Ampere Ratings, Catalog Numbers

AMPERE RATING	CATALOG NUMBER	OUTLINE FIG.	AMPERE RATING	CATALOG NUMBER	OUTLINE FIG.	AMPERE RATING	CATALOG NUMBER	OUTLINE FIG.	AMPERE RATING	CATALOG NUMBER	OUTLINE FIG.
1	A25X1-1	1	90	A25X90-4	3	400	A25X400-4TA	4	2000	A25X2000-128	6
2	A25X2-1	1	100	A25X100-4	3	400	A25X400-4TI	3	2000	A25X2000-128TA	7
3	A25X3-1	1	100	A25X100-4TA	4	450	A25X450-4	3	2500	A25X2500-128	6
4	A25X4-1	1	100	A25X100-4TI	3	500	A25X500-4	3	2500	A25X2500-128TA	7
5	A25X5-1	1	125	A25X125-4	3	500	A25X500-4TA	4	3000	A25X3000-128	6
6	A25X6-1	1	130	A25X130-4	3	500	A25X500-4TI	3	3500	A25X3500-128	6
7	A25X7-1	1	150	A25X150-4	3	550	A25X550-4	3	3500	A25X3500-128TA	7
8	A25X8-1	1	150	A25X150-4TA	4	600	A25X600-4	3	4000	A25X4000-128	6
9	A25X9-1	1	150	A25X150-4TI	3	600	A25X600-4TA	4	4500	A25X4500-128	6
10	A25X10-1	1	175	A25X175-4	3	600	A25X600-4TI	3			
12	A25X12-1	1	200	A25X200-4	3	700	A25X700-4	3			
15	A25X15-1	1	200	A25X200-4TA	4	700	A25X700-128	5			
20	A25X20-1	1	200	A25X200-4TI	3	800	A25X800-4	3			
25	A25X25-1	1	225	A25X225-4	3	800	A25X800-4TA	4			
30	A25X30-1	1	250	A25X250-4	3	800	A25X800-128	5			
35	A25X35-4	2	250	A25X250-4TI	3	1000	A25X1000-128	5			
40	A25X40-4	2	300	A25X300-4	3	1000					
50	A25X50-4	2	300	A25X300-4TA	4	1200	A25X1200-128	5			
60	A25X60-4	2	300	A25X300-4TI	3	1500	A25X1500-128	6			
70	A25X70-4	3	350	A25X350-4	3	1500	A25X1500-128TA	7			
80	A25X80-4	3	400	A25X400-4	3	1600	A25X1600-128	6			

For ampere ratings and styles not listed, call Technical Services.

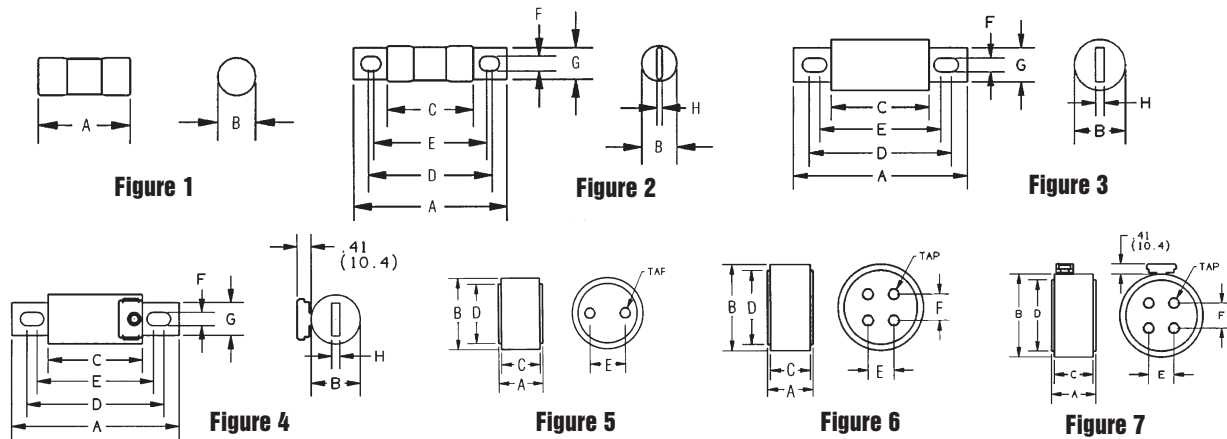

### Dimensions

OUTLINE REF.	MOUNTING TYPE	FIG.	DIMENSIONS - INCHES (mm)								TAP	
			A	B	C	D	E	F	G	H		
A25X1 to 30	1	1	2.00 (50.8)	0.56 (14.2)	-	-	-	-	-	-	-	-
A25X35 to 60	4	2	3.19 (81.0)	0.81 (20.6)	1.63 (41.4)	2.50 (63.5)	2.25 (57.5)	0.34 (8.6)	0.72 (18.3)	0.13 (3.3)	-	-
A25X70 to 200	4	3	3.13 (79.5)	1.22 (31.0)	1.63 (41.4)	2.44 (62.0)	2.31 (58.7)	0.31 (7.9)	1.00 (2.54)	0.19 (4.8)	-	-
A25X225 to 700	4, 4TA*	3, 4*	3.84 (97.5)	1.50 (38.1)	1.59 (40.1)	2.91 (73.9)	2.28 (57.9)	0.41 (10.4)	1.00 (25.4)	0.25 (6.4)	-	-
A25X800	4, 4TA*	3, 4*	3.84 (97.5)	2.00 (50.8)	1.59 (40.4)	2.91 (73.9)	2.28 (57.9)	0.41 (10.4)	1.50 (38.1)	0.25 (6.4)	-	-
A25X700 to 1200	128	5	2.59 (65.8)	3.00 (76.2)	2.34 (59.4)	2.50 (63.5)	1.50 (38.1)	-	-	-	3/8-24-1/2 Deep	-
A25X1500 to 2500	128, 128TA*	6, 7*	2.59 (65.8)	3.50 (88.9)	2.34 (59.4)	3.00 (76.2)	1.50 (38.1)	1.50 (38.1)	-	-	3/8-24-1/2 Deep	-
A25X3000 to 4500	128, 128TA*	6, 7*	2.59 (65.8)	4.50 (114)	2.34 (59.4)	3.75 (95.3)	1.50 (38.1)	1.50 (38.1)	-	-	1/2-20-1/2 Deep	-

\* Optional Trigger Actuator (TA)



# A25X

## SEMICONDUCTOR PROTECTION FUSES

A25X70 to 4500

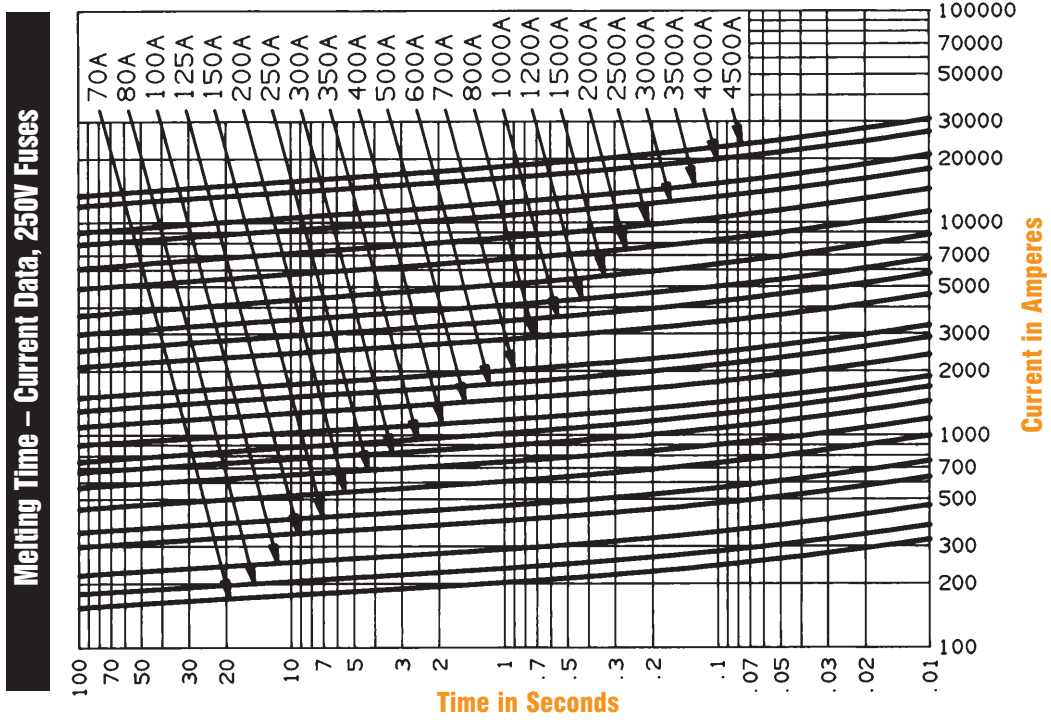

A25X1 to 60

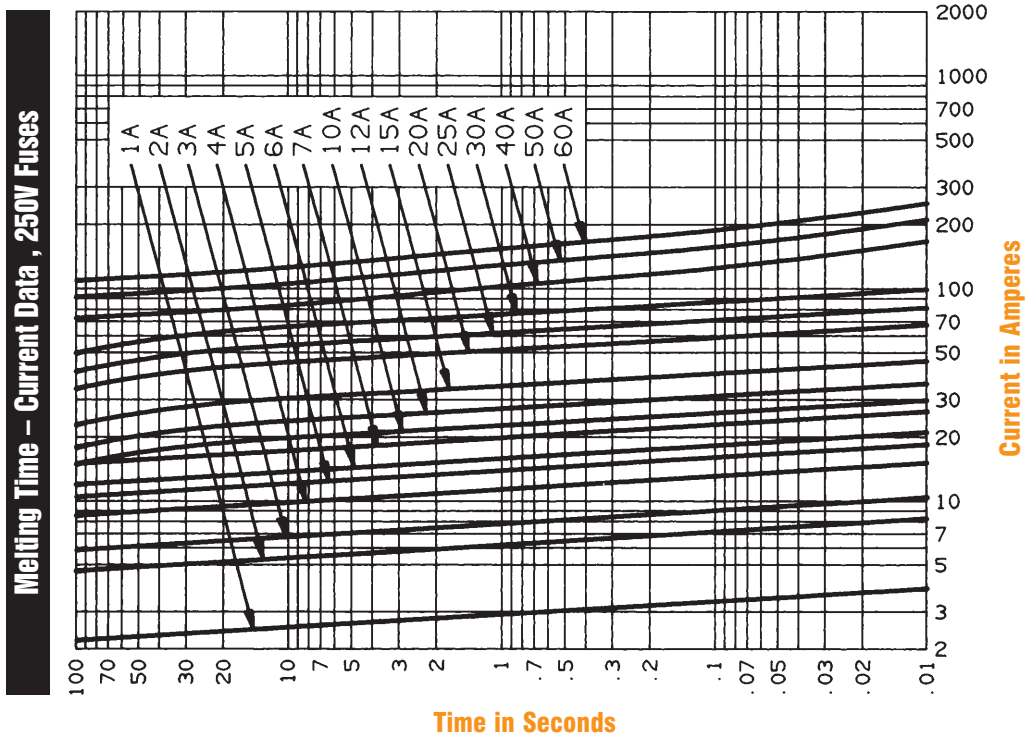

# A25X

## SEMICONDUCTOR PROTECTION FUSES

**Peak Let-Thru Current Data – A25X1 to 60, 250Volts AC**

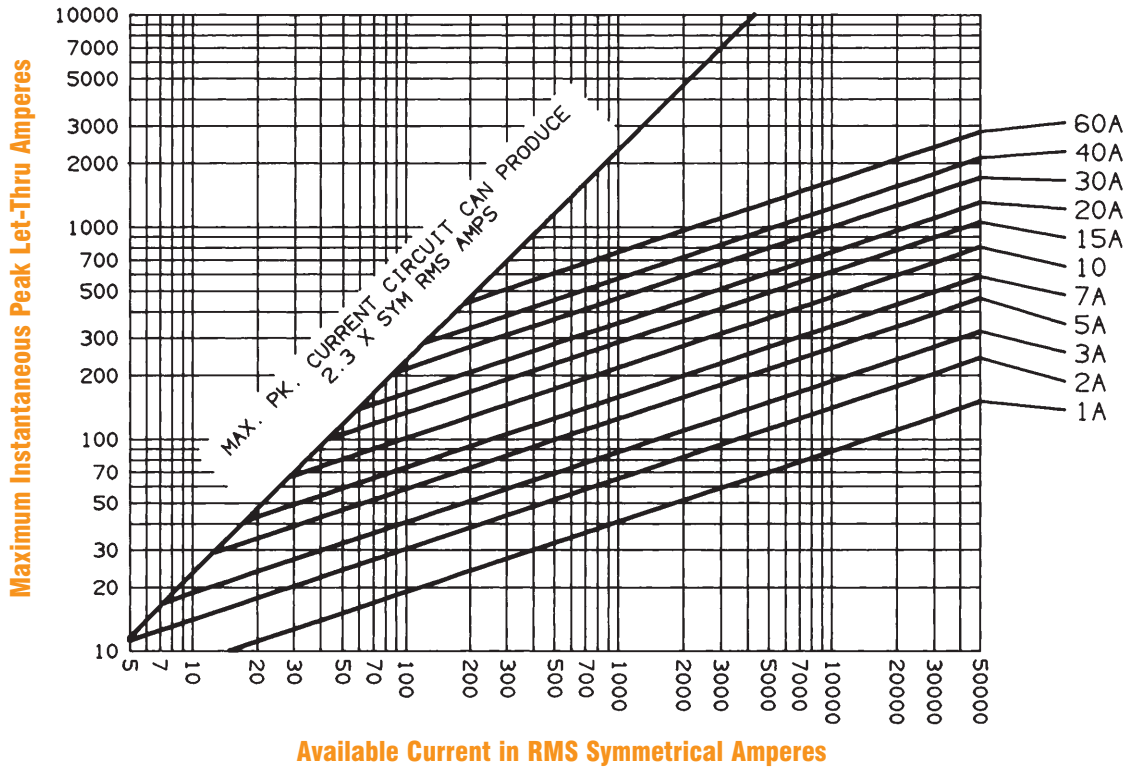

**Peak Let-Thru Current Data – A25X70 to 4000, 250 Volts AC**

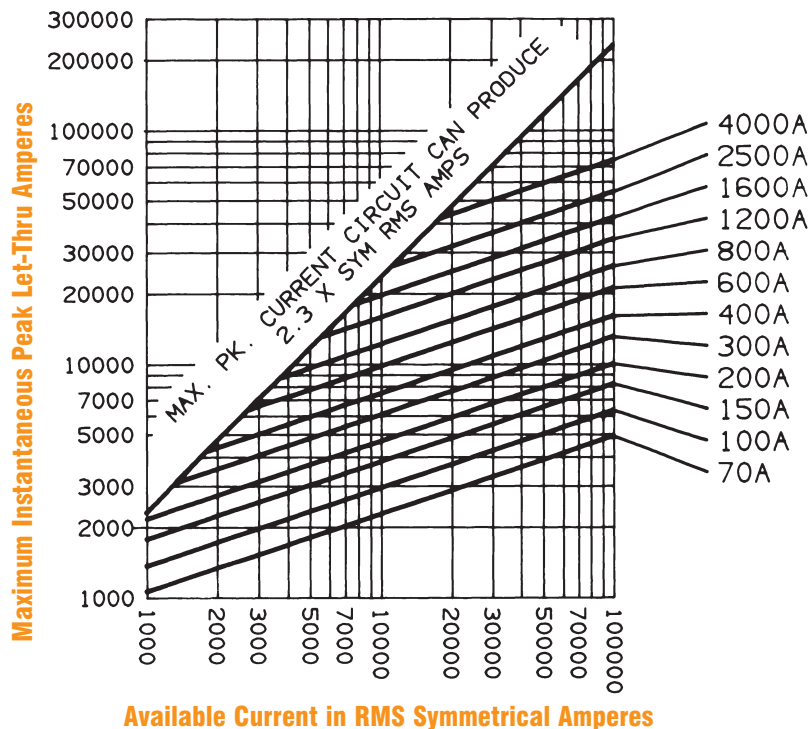

# A25X

## SEMICONDUCTOR PROTECTION FUSES

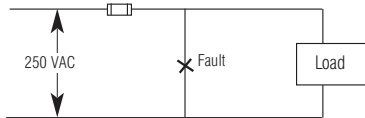

Fig. A

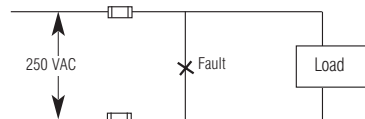

Fig. B

### I<sup>2</sup>t Data – 250 Volts AC

FUSE AMPERE RATING	I <sup>2</sup> t DATA		
	MELTING (A <sup>2</sup> s)	CLEARING AT 250V	
		1 FUSE (FIG. A) (A <sup>2</sup> s)	2 FUSES IN SERIES (FIG. B) (A <sup>2</sup> s)
1	.033	.27	.18
2	.17	1.5	.98
3	.32	3.8	2.5
4	.85	6.9	4.6
5	1.3	8.7	5.8
6	1.9	9.6	6.4
7	2.7	13	8.4
8	5.0	24	16
9	8.6	31	21
10	13	39	26
12	18	54	36
15	20	60	40
20	36	110	72
25	56	170	110
30	81	240	160
35	95	540	380
40	120	690	460
50	190	960	640
60	280	1,400	960
70	420	3,500	2,100
80	550	4,600	2,300
90	700	5,800	2,500
100	860	7,200	3,000
125	1,300	11,000	4,100
150	2,000	16,000	6,000
175	2,600	22,000	8,000
200	3,400	29,000	11,000
225	4,300	36,000	13,000
250	5,400	45,000	16,000
300	7,700	65,000	24,000
350	11,000	88,000	32,000
400	14,000	110,000	42,000
450	18,000	140,000	53,000
500	22,000	180,000	66,000
600	31,000	260,000	95,000
700	42,000	350,000	130,000
800	55,000	460,000	170,000
1,000	86,000	720,000	260,000
1,200	125,000	1,000,000	380,000
1,500	200,000	1,600,000	600,000
1,600	220,000	1,800,000	680,000
2,000	350,000	2,900,000	1,100,000
2,500	550,000	4,500,000	1,600,000

### Watts Loss at Rated Current

AMPERE RATING	WATTS LOSS (w)	AMPERE RATING	WATTS LOSS (w)	AMPERE RATING	WATTS LOSS (w)
70	4.4	250	19	1000	57
80	5.1	300	22	1200	70
90	5.5	350	26	1500	88
100	6.5	400	30	2000	122
125	7.6	450	32	2500	142
150	9.3	500	37	3000	164
175	11	600	45	3500	191
200	13	700	55	4000	198
225	15	800	51	4500	211
				5000	228

### Watts Loss Correction vs. Percent Rated Current

